

# **Eklind**®



**Eklind**®

**E-PRODUCT CATALOG** ♦ **FEBRUARY 1, 2019**

**WWW.EKLINDTOOL.COM**

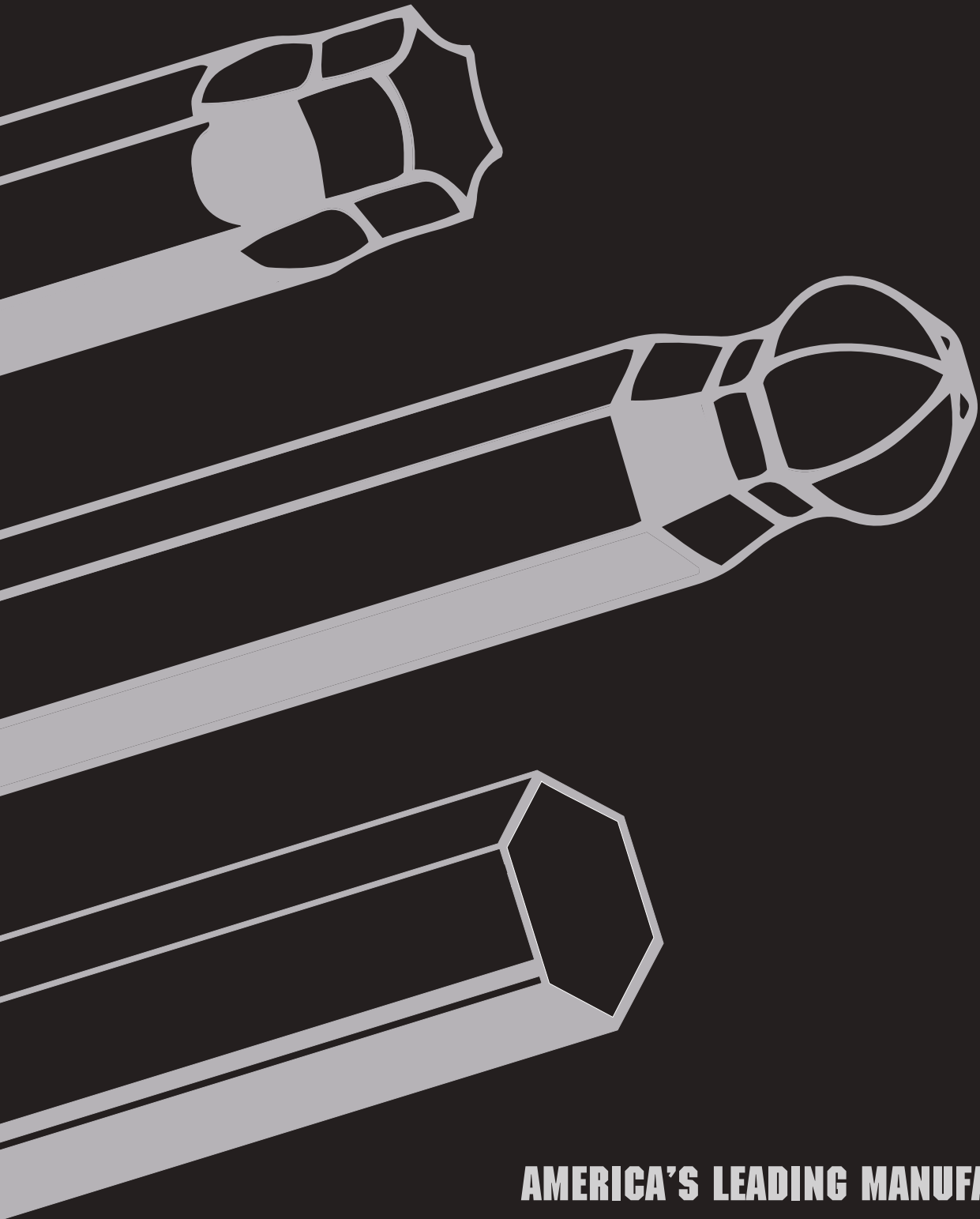

**AMERICA'S LEADING MANUFACTURER OF  
HIGH QUALITY HEX KEYS SINCE 1950**



Page	Contents	TORX <sup>®</sup>			HEX		
		Ball / Torx <sup>®</sup>	Tamper Resistant	Standard Torx <sup>®</sup>	Ball Hex	Tamper Resistant	Standard Hex
A1 - A3	New Product						
1-2	Combination Sets			★	⬡		⬡
3-4	Ergo-Fold™ Keys Sets		★	★	⬡		⬡
5-6	Classic Fold-Up Sets			★	⬡		⬡
7-8	Ball-Hex-L™ Key Sets in Molded Holders	★			⬡		
9-10	Hex-L® Key Sets in Molded Holders		★	★			⬡
11-12	Hex-L® Keys in Metal Boxes			★	⬡		⬡
13-14	Hex-L® Keys in Vinyl Pouches	★	★	★		⬡	⬡
15-16	Power-T™ Key Sets			★	⬡		⬡
17-18	Cushion & Standard Grip T-Key Sets				⬡		
19	PSD™ Precision Screwdriver Sets			★	⬡		⬡
20	Ball-Hex Drivers™						⬡
21-22	Individual Ball-Hex-L™ Keys	★			⬡		
23-25	Individual Hex-L® Keys					⬡	⬡
26	Individual Torx® L-Keys		★	★			
27	Individual Power-T™ Keys			★	⬡		⬡
28-29	Individual Cushion & Standard Grip T-Keys						
30	Individual PSD™ Precision Screwdrivers			★	⬡		⬡
31	Individual Ball-Hex Drivers™				⬡		
32-33	Replacemet Fold-Up Keys			★	⬡		⬡
33	L-Key Holders & Metal Boxes	★	★	★	⬡		⬡





# DOUBLE-BALL-HEX-L KEY™

ITEM NO.	NO. of KEYS	17213	17609
17222	22		

ITEM NO.	SERIES	NO. of KEYS	KEY SIZES											
			.050	1/16	5/64	3/32	7/64	1/8	9/64	5/32	3/16	7/32	1/4	5/16
17213	X-Long	13	[Red line indicating sizes 1/16 through 3/8]											

ITEM NO.	SERIES	NO. of KEYS	KEY SIZES							
			1.5	2.0	2.5	3.0	4.0	5.0	6.0	8.0
17609	x-Long	9	[Blue line indicating sizes 1.5 through 10.0]							



The full range of motion is 20 degrees

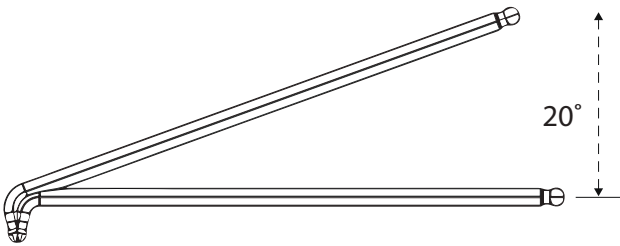

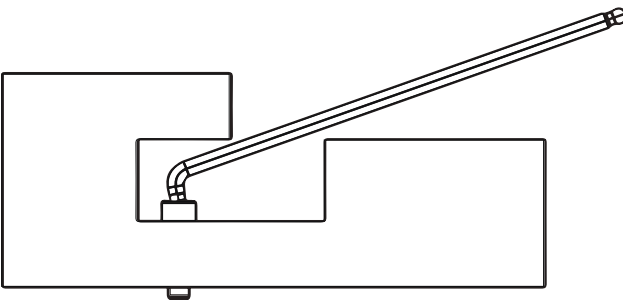
- ◆ Thicker ball tip on short arm for more torque
- ◆ 100° angle for easier entry
- ◆ 20° range of motion
- ◆ Safely access areas that are hard to reach

ITEM NO.	DIMENSIONS		
	TIP SIZE	LONG ARM (INCH)	SHORT ARM (INCH)
<b>DOUBLE BALL END HEX KEYS - INCH SIZES</b>			
19203	.050	3.10	.25
19204	1/16	3.50	.27
19205	5/64	3.90	.29
19206	3/32	4.15	.30
19207	7/64	4.41	.31
19208	1/8	4.75	.33
19209	9/64	5.11	.34
19210	5/32	5.46	.37
19212	3/16	6.15	.41
19214	7/32	6.48	.49
19216	1/4	6.81	.48
19220	5/16	7.55	.62
19224	3/8	8.50	.77

ITEM NO.	DIMENSIONS		
	TIP SIZE	LONG ARM (INCH)	SHORT ARM (INCH)
<b>DOUBLE BALL END HEX KEYS - METRIC SIZES</b>			
19603	1.5	3.50	.27
19604	2.0	3.90	.29
19605	2.5	4.30	.30
19606	3.0	4.90	.34
19608	4.0	5.40	.37
19610	5.0	6.20	.42
1912	6.0	7.00	.49
19616	8.0	7.80	.62
19620	10.0	8.70	.81

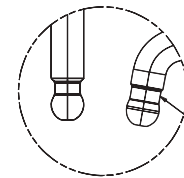

Ball tip on short arm is thicker providing extra strength

# NEW HEX T-KEY LENGTHS

Eklind Hex T-Keys feature a one piece loop handle construction for extra strength. Popular inch and metric keys are **NOW** available in both 12" and 15" lengths. Cushion Grip T-Keys provide extra comfort.

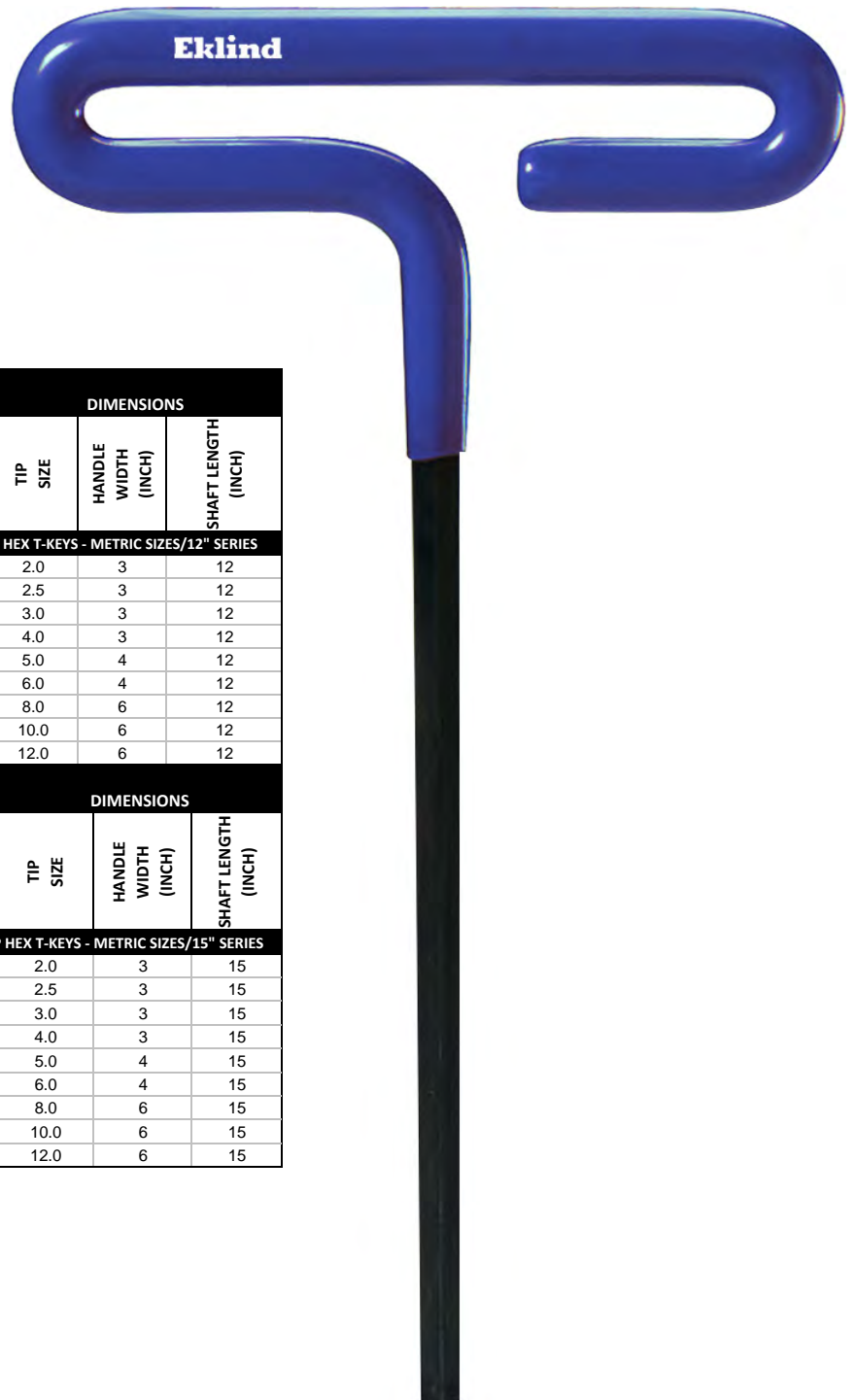

ITEM NO.	DIMENSIONS		
	TIP SIZE	HANDLE WIDTH (INCH)	SHAFT LENGTH (INCH)
<b>CUSHION GRIP HEX T-KEYS - INCH SIZES/12" SERIES</b>			
51205	5/64	3	12
51206	3/32	3	12
51207	7/64	3	12
51208	1/8	3	12
51209	9/64	3	12
51210	5/32	3	12
51212	3/16	4	12
51214	7/32	4	12
51216	1/4	4	12
51220	5/16	6	12
51224	3/8	6	12
51232	1/2	6	12
<b>ITEM NO. DIMENSIONS</b>			
	TIP SIZE	HANDLE WIDTH (INCH)	SHAFT LENGTH (INCH)
<b>CUSHION GRIP HEX T-KEYS - INCH SIZES/15" SERIES</b>			
51505	5/64	3	15
51506	3/32	3	15
51507	7/64	3	15
51508	1/8	3	15
51509	9/64	3	15
51510	5/32	3	15
51512	3/16	4	15
51514	7/32	4	15
51516	1/4	4	15
51520	5/16	6	15
51524	3/8	6	15
51532	1/2	6	15

ITEM NO.	DIMENSIONS		
	TIP SIZE	HANDLE WIDTH (INCH)	SHAFT LENGTH (INCH)
<b>CUSHION GRIP HEX T-KEYS - METRIC SIZES/12" SERIES</b>			
54220	2.0	3	12
54225	2.5	3	12
54230	3.0	3	12
54240	4.0	3	12
54250	5.0	4	12
54260	6.0	4	12
54280	8.0	6	12
54290	10.0	6	12
54292	12.0	6	12
<b>ITEM NO. DIMENSIONS</b>			
	TIP SIZE	HANDLE WIDTH (INCH)	SHAFT LENGTH (INCH)
<b>CUSHION GRIP HEX T-KEYS - METRIC SIZES/15" SERIES</b>			
54520	2.0	3	15
54525	2.5	3	15
54530	3.0	3	15
54540	4.0	3	15
54550	5.0	4	15
54560	6.0	4	15
54580	8.0	6	15
54590	10.0	6	15
54592	12.0	6	15

# NEW POWER-T™ TORX® LENGTH

Eklind Power-T™ Keys are manufactured from Eklind Alloy Steel™. They are heat treated for optimum strength and ductility. Power-T™ T-Handle Hex Keys have a soft, textured overmold for extra comfort, slip resistance and safety. **NOW** available in 9" length.



- Soft textured overmold for extra comfort
- Provides extra reach and extra leverage
- Sizes permanently marked on handle
- Color-coded for easy identification

ITEM NO.	SERIES	NO. of KEYS	KEY SIZES												
			T6	T7	T8	T9	T10	T15	T20	T25	T27	T30	T40	T45	T50
<b>SETS IN POUCH</b>															
68988	Long	8													
68991	Long	11													
<b>SETS IN STAND</b>															
68992	Long	11													

ITEM NO.	DIMENSIONS		
	TIP SIZE	HANDLE WIDTH (INCH)	SHAFT LENGTH (INCH)
<b>POWER-T™ TORX® KEYS / 9" SERIES</b>			
68906	T6	3	9
68907	T7	3	9
68908	T8	3	9
68909	T9	3	9
68910	T10	3	9
68915	T15	3	9
68920	T20	3	9
68925	T25	3	9
68927	T27	4	9
68930	T30	4	9
68940	T40	4	9
68945	T45	5	9
68950	T50	5	9

★ Torx® tools drive both Torx® and Torx Plus® Fasteners.

TORX® tools drive all TORX®, TORX PLUS® and "star" fasteners. TORX® and TORX PLUS® are registered trademarks of Acument Intellectual Properties, LLC.

# COMBINATION SETS

Eklind Combo Sets are a great choice when both inch and metric Hex Keys are needed. These sets offer convenience as well as value. Combo Sets include popular inch and metric sizes in Ball-Hex, Standard Hex and Torx® style tips.

## Ball•Hex•L™ Key Sets



**TURNS 360° AT UP TO A 35° ANGLE**

## Hex•L® Key Sets



**THE INDUSTRY STANDARD**

## Ergo•Fold™ Key Sets



**FEEL THE DIFFERENCE!**

## Classic Fold•Up Key Sets



**EXTRA LEVERAGE  
EXTRA TORQUE  
EXTRA REACH**



# COMBINATION SETS

Eklind Combo Sets are a great choice when both inch and metric Hex Keys are needed. These sets offer convenience as well as value. Combo Sets include popular inch and metric sizes in Ball-Hex, Standard Hex and Torx® style tips.

## Ball•Hex•L™ Key Sets



Turns 360° at UP to a 35° angle

## Eklind BALL•HEX•L™ COMBO SETS

ITEM NO.	SERIES	NO. of KEYS	KEY SETS														
			13113	13211	13213	13313	13509	13607	13609	13709	17313	17709	25171	25461	25581	25582	
13218	Long	18															
13122	Stubby	22															
13222	Long	22															
13228	Long & Ergo	28															
13281	Long & Ergo	30															
13282	Long & Ergo	30															
13322	Bright	22															
17322	X-Long & Bright	22															

## Hex•L® Key Sets



THE INDUSTRY STANDARD

## Eklind HEX•L® COMBO SETS

ITEM NO.	SERIES	NO. of KEYS	KEY SETS											
			10111	10113	10213	10907	10909	10909	10907	11111	11113	11213	11909	11909
10022	Long & Short	22												
10222	Long	22												
10223	Long	22												
10122	Short	22												
10229	Long	29												
10518	Short	18												
11122	Bright	22												
11222	Bright	22												

## Ergo•Fold™ Key Sets



FEEL THE DIFFERENCE!

## Eklind ERGO•FOLD™ COMBO SETS

ITEM NO.	NO. of KEYS	KEY SETS								
		13213	13609	25161	25171	25461	25581	25611	25911	25912
25013	13									
25015	15									
25016	16									
25024	24									
25028	28									
25030	30									
25036	36									
29016	16									
29022	22									

## Classic Fold•Up Key Sets



EXTRA LEVERAGE  
EXTRA TORQUE  
EXTRA REACH

## Eklind CLASSIC FOLD•UP COMBO SETS

ITEM NO.	NO. of KEYS	KEY SETS		
		20911	21171	22571
26160	16			
29171	23			

# ERGO•FOLD™ KEY SETS

## Feel The Difference!

Ergo-Fold™ Key Sets feature a composite grip handle shaped for superior ergonomics. A soft cushion-grip insert offers comfort and slip resistance, while a hard shell provides maximum strength. Eklind keys provide extra reach for safer clearance from your work.



Eklind Ergo-Fold™ Key Sets can be used at a right angle to generate maximum torque. Additionally, they can be used as a screwdriver, with the key folded out to a firm stop. As with all other Eklind Hex Key products, we use the highest quality Eklind Alloy Steel™ that is heat treated for superior strength and finished to resist rust. Eklind keys provide maximum torque and wear resistance.

### Inch, Metric **AND** Torx® Sets

A variety of inch and metric sets are available in both regular Hex and Ball-Hex series. Small, medium and large size handles offer the proper amount of torque for the application.

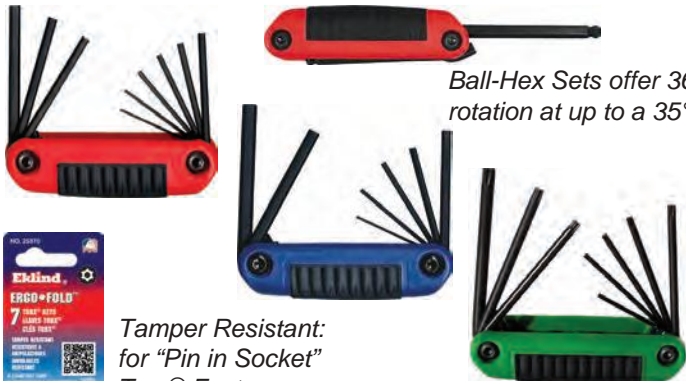

Ball-Hex Sets offer 360° of rotation at up to a 35° angle.



Tamper Resistant: for "Pin in Socket" Torx® Fasteners.

 Torx® sets cover a wide scope of applications including; automotive headlights, taillights and trim, power tools, carbide inserts in cutting tools, appliances and electronics.

### Combo Sets



### Screwdriver Sets

These convenient sets are ideal in the glove compartment and kitchen or desk drawers.



## As Strong As Steel... Guaranteed Forever!

# ERGO-FOLD™ KEY SETS

Ergo-Fold™ Key Sets feature a composite grip handle shaped for superior ergonomics. A soft cushion-grip insert offers comfort and slip resistance, while a hard shell provides maximum strength. Eklind keys provide extra reach for safer clearance from your work.



## Eklind ERGO-FOLD™ INCH SETS

ITEM NO.	HANDLE SIZE	NO. of KEYS	KEY SIZES														
			.050	1/16	5/64	3/32	7/64	1/8	9/64	5/32	3/16	7/32	1/4	5/16	3/8		
<b>BALL END INCH SETS</b>																	
25519	5.25	5															
25919	4.25	9															
<b>HEX INCH SETS</b>																	
25611	5.25	6															
25911	4.25	9															
25912	3.63	9															



## Eklind ERGO-FOLD™ METRIC SETS

ITEM NO.	HANDLE SIZE	NO. of KEYS	KEY SIZES											
			1.5	2.0	2.5	3.0	4.0	5.0	6.0	7.0	8.0	10.0		
<b>BALL END METRIC SETS</b>														
25159	5.25	5												
25169	3.63	6												
<b>HEX METRIC SETS</b>														
25161	5.25	6												
25171	3.63	7												
25172	5.25	7												
25181	5.25	8												



## Eklind ERGO-FOLD™ TORX® SETS

ITEM NO.	HANDLE SIZE	NO. of KEYS	KEY SIZES											
			T6	T7	T8	T9	T10	T15	T20	T25	T27	T30	T40	
<b>TORX® SETS</b>														
25581	4.25	8												
25582	3.63	8												
<b>TAMPER RESISTANT TORX® SETS</b>														
25570	4.25	7												



## Eklind ERGO-FOLD™ SCREWDRIVER SETS

ITEM NO.	HANDLE SIZE	NO. of KEYS	KEY SIZES									
			1/8" FB	3/16" FB	1/4" FB	#1 PB	AWL	4.0MM	5.0MM	6.0MM	T15	
<b>SCREWDRIVER SETS</b>												
25461	3.63	6										
25651	3.63	5										



# CLASSIC FOLD-UP SETS

This versatile line of tools is available in inch and metric Hex Keys, Ball-Hex Keys, Torx® Keys or Screwdriver Bits. Each set of keys is housed in a one-piece comfort grip handle designed to operate smoothly as well as hold the keys firmly in any desired work position.

## Combo Sets



## Inch and Metric Sets



A variety of Hex and Ball-Hex Sets are available, covering the full range of inch and metric sizes.



## Screwdriver Sets



These convenient sets offer flat blades, #1 Phillips, a scratch awl and the popular T15 Torx® Key. They are easily kept in the glove compartment and kitchen or desk drawers.



## Torx® Sets



Torx® Sets cover a wide scope of applications including; automotive headlights taillights and trim, power tools, carbide inserts in cutting tools, appliances and electronics.

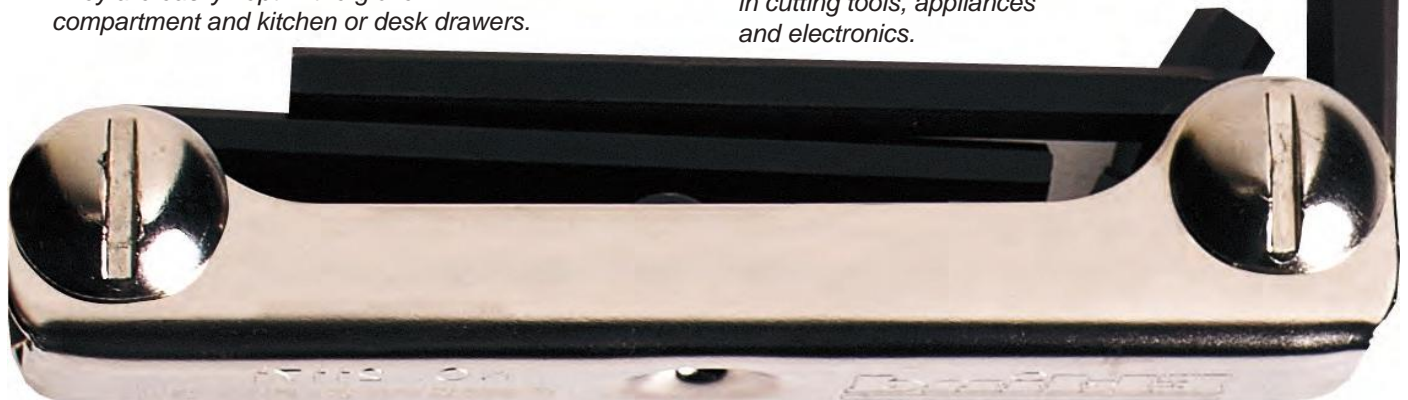



# CLASSIC FOLD-UP SETS

This versatile line of tools is available in inch and metric Hex Keys, Ball-Hex Keys, Torx® Keys or Screwdriver Bits. Each set of keys is housed in a one-piece comfort grip handle designed to operate smoothly, as well as hold the keys firmly in any desired work position.



## CLASSIC FOLD-UP INCH SETS

ITEM NO.	HANDLE SIZE	NO. of KEYS	KEY SIZES												
			.050	1/16	5/64	3/32	7/64	1/8	9/64	5/32	3/16	7/32	1/4	5/16	3/8
<b>BALL END INCH SETS</b>															
20519	5.25	5													
20719	3.00	7													
20919	4.25	9													
<b>HEX INCH SETS</b>															
20511	5.25	5													
20811	3.00	8													
20812	5.25	8													
20911	4.25	9													
20912	3.63	9													

## CLASSIC FOLD-UP METRIC SETS

ITEM NO.	HANDLE SIZE	NO. of KEYS	KEY SIZES							
			1.5	2.0	2.5	3.0	4.0	5.0	6.0	8.0
<b>BALL END METRIC SETS</b>										
21158	3.00	5								
21159	5.25	5								
<b>HEX METRIC SETS</b>										
21151	5.25	6								
21171	3.63	7								
21172	4.25	7								

## CLASSIC FOLD-UP TORX® SETS

ITEM NO.	HANDLE SIZE	NO. of KEYS	KEY SIZES										
			T6	T7	T8	T9	T10	T15	T20	T25	T27	T30	T40
<b>TORX® SETS</b>													
22571	4.25	7											
22572	3.00	7											

## CLASSIC FOLD-UP SCREWDRIVER SETS

ITEM NO.	HANDLE SIZE	NO. of KEYS	KEY SIZES							
			1/8" FB	3/16" FB	1/4" FB	#1 PB	AWL	4.0MM	5.0MM	6.0MM
<b>SCREWDRIVER SETS</b>										
22451	3.63	5								
22461	3.63	6								
22651	3.63	5								

# BALL•HEX•L™ KEY SETS IN MOLDED HOLDERS

Eklind Ball-Hex-L™ Keys are designed with a ball profile on the long arm. This feature provides 360 degrees of rotation at up to a 35 degree angle. The burr-free short arm allows the user to apply maximum torque in required applications. Ball-Hex-L™ Sets are available in a variety of inch and metric sizes, and in Long, Bright, Extra-Long Bright and Stubby series.



## Ball•Hex•L™ Key Sets

**NEW "Bright" Series**  
Our new Bright series and X-Long Bright series have been added to Eklind's Ball-Hex-L™ Key family. These keys are manufactured from the same high quality standards that are consistent with Eklind's entire line of Hex Key Products.

## Ball•Hex•L™ Combination Sets

Combination Sets are available in our most popular inch and metric sizes, and in Ball-Hex-L™ Sets as well as Ball-Hex-L™ and Ergo-Fold™ Sets.



## Ball•Torx® Key Sets

Ball Torx® L-Keys have a standard Torx® tip on the short arm. The long arm has a ball tip engineered to drive the Torx® fastener at up to a 35 degree angle.

# BALL-HEX-L™ KEY SETS IN MOLDED HOLDERS

Eklind Ball-Hex-L™ Keys are designed with a ball profile on the long arm. This feature provides 360 degrees of rotation at up to a 35 degree angle. The burr-free short arm allows the user to apply maximum torque in required applications. Ball-Hex-L™ Sets are available in a variety of inch and metric sizes, and in Long, Bright, Extra-Long Bright and Stubby series.



Long

## Eklind BALL-HEX-L™ INCH SETS

ITEM NO.	SERIES	NO. of KEYS	KEY SIZES												
			.050	1/16	5/64	3/32	7/64	1/8	9/64	5/32	3/16	7/32	1/4	5/16	3/8
<b>IN MOLDED PLASTIC HOLDERS</b>															
13111	Stubby	11	[Red lines indicating key sizes]												
13113	Stubby	13	[Red lines indicating key sizes]												
13207	Long	7	[Red lines indicating key sizes]												
13211	Long	11	[Red lines indicating key sizes]												
13212	Long	12	[Red lines indicating key sizes]												
13213	Long	13	[Red lines indicating key sizes]												
13297	Long	7	[Red lines indicating key sizes]												
13313	Bright	13	[Red lines indicating key sizes]												
13313	Long	13	[Red lines indicating key sizes]												
17213	Double Ball	13	[Red lines indicating key sizes]												
17213	Bright	13	[Red lines indicating key sizes]												
17313	X-Long	13	[Red lines indicating key sizes]												

## Eklind BALL-HEX-L™ METRIC SETS

ITEM NO.	SERIES	NO. of KEYS	KEY SIZES							
			1.5	2.0	2.5	3.0	4.0	5.0	6.0	8.0
<b>IN MOLDED PLASTIC HOLDERS</b>										
13507	Stubby	7	[Blue lines indicating key sizes]							
13509	Stubby	9	[Blue lines indicating key sizes]							
13607	Long	7	[Blue lines indicating key sizes]							
13609	Long	9	[Blue lines indicating key sizes]							
13709	Bright	9	[Blue lines indicating key sizes]							
13709	Double	9	[Blue lines indicating key sizes]							
17609	Ball	9	[Blue lines indicating key sizes]							
17609	Bright	9	[Blue lines indicating key sizes]							
17709	X-Long	9	[Blue lines indicating key sizes]							



Stubby

## Eklind BALL / TORX® SETS

ITEM NO.	SERIES	NO. of KEYS	KEY SIZES						
			T10	T15	T20	T25	T27	T30	T40
<b>IN MOLDED PLASTIC HOLDERS</b>									
10007	Long	7	[Green lines indicating key sizes]						

# HEX•L® & TORX® L SETS IN MOLDED HOLDERS

Eklind L-Keys are produced from the highest quality Eklind Alloy Steel™. They are heat treated for maximum strength and finished to resist rust. Eklind's superior quality provides maximum torque and prevents rounding out of the key or hex socket.



## Hex•L® Key Sets

A variety of inch and metric sets are available in both short and long arm series. These sets are contained in a convenient compact molded holder that firmly retains each key in designated holes. The molded holders are color-coded which makes them instantly identifiable; red for inch sizes, and blue for metric sizes.



## Torx® L•Key Sets

Torx® L-Key Sets are available in popular sizes and in both short and long arm series. They are conveniently contained in a green molded plastic holder with individually sized marked holes. Torx® keys are useful in the following applications: automotive headlights, taillights and trim, power tools, carbide inserts in cutting tools, appliances and electronics.



Tamper Resistant Torx® for "Pin in Socket" Torx® Fasteners.



## Combination Hex•L® Key Sets

A variety of Combination Hex-L® Key Sets are available in popular inch and metric sizes. These sets are contained in separate color-coded molded holders offering convenient, organized tools.





# HEX•L® & TORX® L SETS IN MOLDED HOLDERS



## Eklind HEX•L® INCH SETS

ITEM NO.	SERIES	NO. of KEYS	KEY SIZES												
			.050	1/16	5/64	3/32	7/64	1/8	9/64	5/32	3/16	7/32	1/4	5/16	3/8
<b>IN MOLDED PLASTIC HOLDERS</b>															
10018	Short	18	S	L	L	L	S	L	L	L	L	S	L	L	
10107	Short	7													
10111	Short	11													
10112	Short	12													**
10113	Short	13													
10207	Long	7													
10211	Long	11													
10212	Long	12													
10213	Long	13													
11113	Bright Short	13													
11213	Bright Long	13													

\*\* Available in bulk only (no blister pack)



## Eklind HEX•L® METRIC SETS

ITEM NO.	SERIES	NO. of KEYS	KEY SIZES							
			1.5	2.0	2.5	3.0	4.0	5.0	6.0	8.0
<b>IN MOLDED PLASTIC HOLDERS</b>										
10507	Short	7								
10509	Short	9								
10607	Long	7								
10609	Long	9								
11509	Bright Short	9								
11609	Bright Long	9								



## Eklind TORX® L SETS

ITEM NO.	SERIES	NO. of KEYS	KEY SIZES						
			T10	T15	T20	T25	T27	T30	T40
<b>IN MOLDED PLASTIC HOLDERS</b>									
10807	Short	7							
10907	Long	7							
10707	TR	7							*
11807	Bright Short	7							
11907	Bright Long	7							

\* Tamper Resistant

# HEX•L<sup>®</sup> & TORX<sup>®</sup> LSETS IN METAL BOXES

*Eklind L-Keys are produced from the highest quality Eklind Alloy Steel™. They are heat treated for maximum strength and finished to resist rust. Eklind's superior quality provides maximum torque and prevents rounding out of the key or hex socket.*

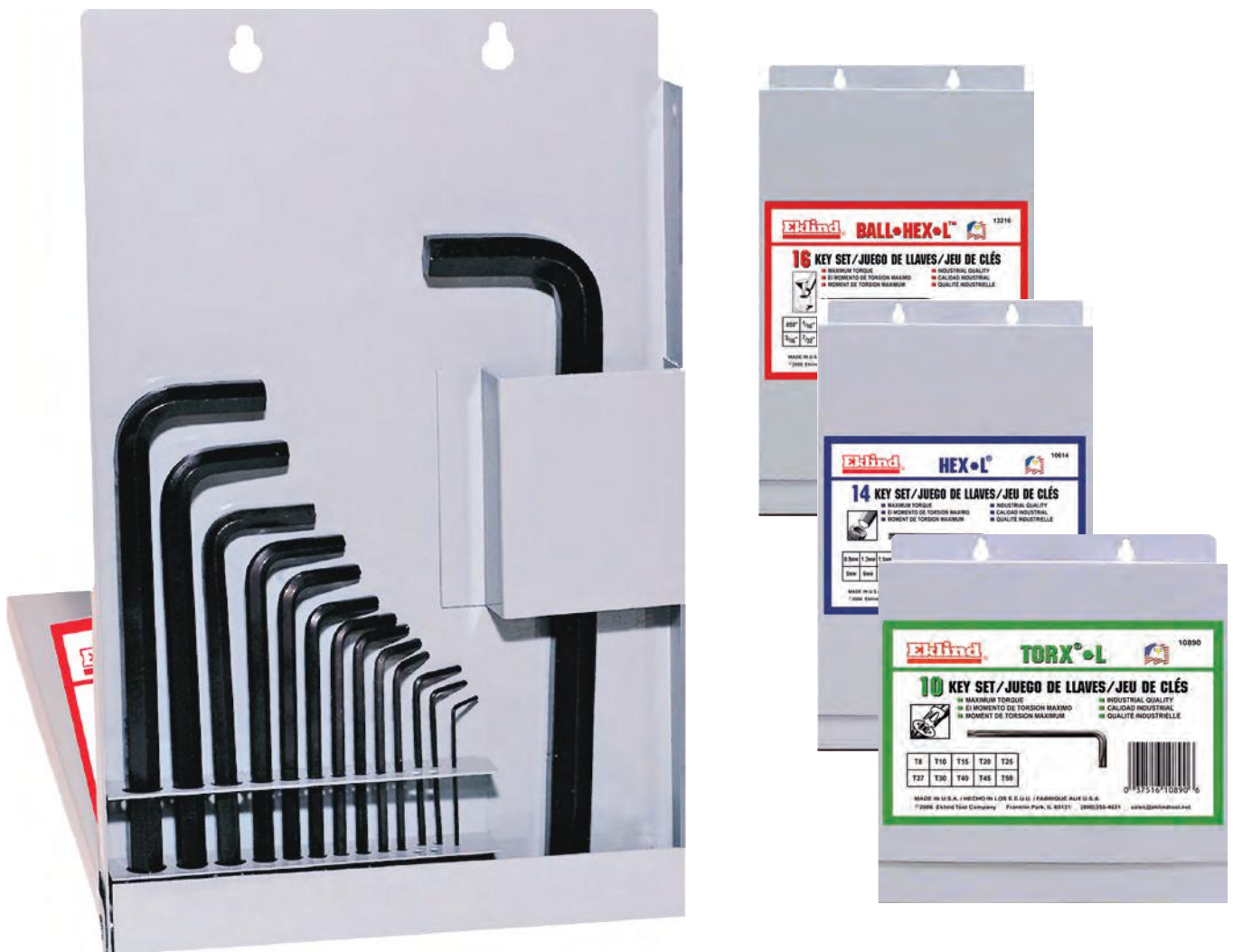

*A variety of Inch, Metric and Torx<sup>®</sup> sets make up this extensive line. Keys are housed into a sturdy metal case that will conveniently hang in the workshop or stand on the workbench. All sets are contained in an index for easy access. Box labels are color-coded, red for inch sizes, blue for metric sizes and green for Torx<sup>®</sup> sizes.*

# HEX•L® & TORX® L SETS IN METAL BOXES

Eklind L-Keys are produced from the highest quality Eklind Alloy Steel™. They are heat treated for maximum strength and finished to resist rust. Eklind's superior quality provides maximum torque and prevents rounding out of the key or hex socket.



## Eklind® HEX•L® INCH SETS

ITEM NO.	SERIES	NO. of KEYS	KEY SIZES																		
			.028	.035	.050	1/16	5/64	3/32	7/64	1/8	9/64	5/32	3/16	7/32	1/4	5/16	3/8	1/2	9/16	5/8	
<b>BALL-HEX-L™ INCH SETS</b>																					
13216	Long	16																			
13293	Long	13																			
<b>HEX-L® INCH SETS</b>																					
10115	Short	15																			
10118	Short	18																			
10214	Long	14																			
10217	Long	17																			
10294	Long	14																			

## Eklind® HEX•L® METRIC SETS

ITEM NO.	SERIES	NO. of KEYS	KEY SIZES													
			0.7	0.9	1.3	1.5	2.0	2.5	3.0	4.0	5.0	6.0	8.0	10.0	12.0	14.0
<b>BALL-HEX-L™ METRIC SETS</b>																
13610	Long	10														
13613	Long	13														
<b>HEX-L® METRIC SETS</b>																
10512	Short	12														
10515	Short	15														
10610	Long	10														
10611	Long	11														
10614	Long	14														

## Eklind® TORX® L SETS

ITEM NO.	SERIES	NO. of KEYS	KEY SIZES														
			T6	T7	T8	T9	T10	T15	T20	T25	T27	T30	T40	T45	T50	T55	T60
10812	Short	12															
10890	Short	10															
10984	Short	14															
10912	Long	12															
10990	Long	10															
10994	Long	14															

A variety of Inch, Metric and Torx® sets make up this extensive line. Keys are housed into a sturdy metal case that will conveniently hang in the workshop or stand on the workbench. All sets are contained in an index for easy access. Box labels are color-coded, red for inch sizes, blue for metric sizes and green for Torx® sizes.

# HEX•L<sup>®</sup> & TORX<sup>®</sup> LSETS IN VINYL POUCHES



Eklind L-Keys are manufactured from the highest quality Eklind Alloy Steel™. They are heat treated for maximum strength and finished to resist rust. Hex corners are sharp and clean. Each key is square cut and burr free for full depth precision fit with the hex socket. Eklind's quality provides maximum torque and prevents rounding out of the key or hex socket.

A variety of inch, metric and Torx® sets are available in both short and long arm series. These sets are available in a sturdy, see through vinyl pouch that can fit compactly into a toolbox or hang in the workshop. The vinyl pouches are color-coded which makes them instantly identifiable.



Tamper Resistant: for "Pin in Socket" Torx®



## Tamper Resistant



Torx® keys are useful in the following applications: automotive headlights, taillights and trim, power tools, carbide inserts in cutting tools, appliances and electronics.



# HEX•L® & TORX® L SETS IN VINYL POUCHES



## Eklind HEX•L® INCH SETS

ITEM NO.	SERIES	NO. of KEYS	KEY SIZES																			
			.028	.035	.050	1/16	5/64	3/32	7/64	1/8	9/64	5/32	3/16	7/32	1/4	5/16	3/8	7/16	1/2	9/16	5/8	3/4
IN VINYL POUCHES																						
10311	6 Inch	11																				
10407	12 Inch	7																				
69113	Short	13																			**	
69207	Short	7																			**	
69211	Short	11																			**	
69213	Long	13																			**	
69215	Short	15																			**	
69209	Long	9																			**	
69218	Short	18			S	S	S	S	S	S	S	S	S	S	S	S	S	S	S	S	**	
87170	Long	18			L	L	L	L	L	L	L	L	L	L	L	L	L	L	L	L	**	
87170	Short	20																			*	
90100	TR	8																			*	

\* Tamper Resistant  
\*\* With Plastic Ring

## Eklind HEX•L® METRIC SETS

ITEM NO.	SERIES	NO. of KEYS	KEY SIZES																			
			0.7	0.9	1.3	1.5	2.0	2.5	3.0	4.0	5.0	6.0	7.0	8.0	9.0	10.0	11.0	12.0	14.0	17.0	19.0	
IN VINYL POUCHES																						
10592	Short	12																				
69205	Short	7																				
69210	Short	10																			**	
69511	Short	11																			**	
69611	Long	11																			**	
87169	Short	17																			**	

\*\* With Plastic Ring



## Eklind TORX® L SETS

ITEM NO.	SERIES	NO. of KEYS	KEY SIZES													
			T6	T7	T8	T9	T10	T15	T20	T25	T27	T30	T40	T45	T50	T55
REGULAR TORX® IN VINYL POUCHES																
10014	Ball	14														
10714	TR	14														*
10810	Short	10														
10814	Short	14														
10897	Short	7														
10910	Long	10														
10914	Long	14														
10997	Long	7														

\* Tamper Resistant

Eklind L-Keys are manufactured from the highest quality Eklind Alloy Steel™. They are heat treated for maximum strength and finished to resist rust. Hex corners are sharp and clean. Each key is square cut and burr-free for full depth precision fit with the hex socket. Eklind's quality provides maximum torque and prevents rounding out of the key or hex socket.

Tamper Resistant: for "Pin in Socket" Fasteners.



A variety of inch, metric and Torx® sets are available in both short and long arm series. These sets are available in a sturdy, see through vinyl pouch that can fit compactly into a toolbox or hang in the workshop. The vinyl pouches are color-coded which makes them instantly identifiable.

# POWER-T™ KEY SETS

**Strong, Increased Comfort, and a Great New Look!**

*Eklind Power-T™ Keys are manufactured from the highest quality Eklind Alloy Steel™ and constructed with a solid steel core for maximum strength. They are heat treated for maximum strength and finished to resist rust. Our new dual-molded grip provides increased comfort and slip resistance for safety.*

*Power-T™ Keys are available in Standard Hex (6" and 9" shaft lengths), Ball-Hex (9" shaft lengths) and Torx® (6" shaft lengths).*



...STRENGTH  
...COMFORT  
...SAFETY



★ Torx® tools drive both Torx® and Torx Plus® Fasteners.

*Eklind's Universal Hex Key Stand will accommodate a wide variety of Eklind Inch, Metric and Torx® products. They can be attached to a wall, to a bench or to each other.*

- Solid Steel Core for Maximum Strength
- Soft Over-Mold for Comfort Offers Slip Resistance
- Provides Extra Torque & Safety
- Sizes Permanently Marked on Handle
- Color-Coded for Easy Identification

*Ball-Hex Keys are designed with greater length allowing access to hard to reach fasteners and providing 360 degrees of rotation at up to a 35 degree angle.*



# POWER-T™ KEY SETS

Eklind Power-T™ Keys are manufactured from the highest quality Eklind Alloy Steel™ and constructed with a solid steel core for maximum strength. They are heat treated for maximum strength and finished to resist rust. Our new dual-molded grip provides increased comfort and slip resistance for safety.

Power-T™ Keys are available in Standard Hex (6" and 9" shaft lengths), Ball-Hex (9" shaft lengths) and Torx® (6" & 9" shaft lengths).

## Eklind POWER-T™ INCH SETS



ITEM NO.	SERIES	ARM LENGTH	NO. of KEYS	KEY SIZES												
				.050	1/16	3/64	3/32	7/64	1/8	9/64	5/32	3/16	7/32	1/4	5/16	3/8
<b>SETS IN STANDS</b>																
60814	Ball	9"	13	*	*											
60614	Hex	6"	13	*	*											
60914	Hex	9"	13	*	*											
<b>SETS IN POUCHES</b>																
60809	Ball	9"	9													
60811	Ball	9"	11													
60609	Hex	6"	9													
60611	Hex	6"	11													
60909	Hex	9"	9													
60911	Hex	9"	11													

\* Indicates L-Key

## Eklind POWER-T™ METRIC SETS

Eklind's Universal Hex Key Stand will accommodate a wide variety of Eklind Inch, Metric and Torx® products. They can be attached to a wall, to a bench or to each other.



ITEM NO.	SERIES	ARM LENGTH	NO. of KEYS	KEY SIZES										
				1.3	1.5	2.0	2.5	3.0	4.0	5.0	6.0	8.0	10.0	
<b>SETS IN STANDS</b>														
64811	Ball	9"	10	*	*									
64611	Hex	6"	10	*	*									
64911	Hex	9"	10	*	*									
<b>SETS IN POUCHES</b>														
64806	Ball	9"	6											
64808	Ball	9"	8											
64606	Hex	6"	6											
64608	Hex	6"	8											
64906	Hex	9"	6											
64908	Hex	9"	8											

\* Indicates L-Key

## Eklind POWER-T™ TORX® SETS

ITEM NO.	SERIES	ARM LENGTH	NO. of KEYS	KEY SIZES												
				T6	T7	T8	T9	T10	T15	T20	T25	T27	T30	T40	T45	T50
<b>SETS IN STANDS</b>																
68692	Torx®	6"	11													
68992	Torx®	9"	11													
<b>SETS IN POUCHES</b>																
68688	Torx®	6"	8													
68988	Torx®	9"	8													
68689	Torx®	6"	8													
68691	Torx®	6"	11													
68991	Torx®	9"	11													

# HEX T-KEY SETS

Eklind Hex T-Keys feature a one piece loop handle construction for extra strength. Hex T-Key sets are available in a stand or with a pouch. Stand sets can be attached to a wall or to a bench. Pouch sets fit compactly into a toolbox or hang in the work shop. Popular inch and metric sets are available in both 6" and 9" lengths. Cushion Grip Sets provide extra comfort. Standard Grip Sets offer a more economical option.



# HEX T-KEY SETS

Eklind Hex T-Keys feature a one piece loop handle construction for extra strength. Hex T-Key sets are available in a stand or with a pouch. Stand sets can be attached to a wall or to a bench. Pouch sets fit compactly into a toolbox or hang in the work shop. Inch and metric sets are available in 6, 9, 12 and 15 inch lengths. Cushion Grip Sets provide extra comfort. Standard Grip Sets offer a more economical option.



## Eklind HEX T-KEY INCH SETS

ITEM NO.	HANDLE	ARM LENGTH	NO. of KEYS	KEY SIZES											
				5/164	3/32	7/164	1/8	9/164	5/32	3/16	7/32	1/4	5/16	3/8	
<b>SETS IN STANDS</b>															
50160	Cushion	6"	10												
50190	Cushion	9"	10												
30160	Standard	6"	10												
30190	Standard	9"	10												
<b>SETS IN POUCHES</b>															
53610	Cushion	6"	10												
53910	Cushion	9"	10												
53168	Cushion	6"	8												
53198	Cushion	9"	8												
53211	Cushion	12"	11												
53511	Cushion	15"	11												
33610	Standard	6"	10												
33910	Standard	9"	10												
33168	Standard	6"	8												
33198	Standard	9"	8												



## Eklind HEX T-KEY METRIC SETS

ITEM NO.	HANDLE	ARM LENGTH	NO. of KEYS	KEY SIZES						
				2.0	2.5	3.0	4.0	5.0	6.0	8.0
<b>SETS IN STANDS</b>										
56168	Cushion	6"	8							
56198	Cushion	9"	8							
36168	Standard	6"	8							
36198	Standard	9"	8							
<b>SETS IN POUCHES</b>										
55208	Cushion	12"	8							
55508	Cushion	15"	8							
55168	Cushion	6"	8							
55198	Cushion	9"	8							
55166	Cushion	6"	6							
55196	Cushion	9"	6							
35168	Standard	6"	8							
35198	Standard	9"	8							
35165	Standard	6"	5							
35195	Standard	9"	5							

# PSD™ KEY SETS

## Professional Precision Screwdrivers

Eklind PSD™ Professional Precision Screwdrivers are manufactured with the same high quality standards that has made Eklind Tool Company the leading manufacturer of American made Hex Key products. A bigger, tapered, ergonomic handle is designed to offer professionals comfort as well as control. Rotating end-caps maintain finger tip control. Tip styles include Hex, Ball-Hex, Slotted, Phillips and Torx®.



- Big, Comfortable Handle
- Spinner-Cap for Precise Control
- Precision Machined Tip
- Sizes are Permanently Marked on Cap
- Soft, Ergo Grip
- Oil & Chemical Resistant



### Eklind PSD™ INCH & METRIC SETS

ITEM NO.	TIP STYLE	NO. of KEYS	KEY SIZES																			
			.028	.035	.050	1/16	5/64	3/32	7/64	1/8	9/64	5/32	0.7	0.9	1.3	1.5	2.0	2.5	3.0	4.0		
92300	Hex	10	[Red bar]																			
92500	Ball-Hex	8		[Red bar]																		
92400	Hex	8										[Blue bar]										
92600	Ball-Hex	6												[Blue bar]								



### Eklind PSD™ SCREWDRIVER & TORX® SETS

ITEM NO.	TIP STYLE	NO. of KEYS	KEY SIZES																				
			1.0	1.5	2.0	2.5	3.0	4.0	#000	#00	#0	#1	T3	T4	T5	T6	T7	T8	T9	T10	T15	T20	
92199	SD	10	[Yellow bar]																				
92200	TORX®	10															[Green bar]						



# BALL•HEX•DRIVERS™

Ball-Hex-Drivers™ provide 360° of rotation at up to a 35° angle. Large diameter tools have bigger handles for better grip and superior torque. Small diameter tools feature a precision style handle with a finger rest at the top. Handles are color coded; red for inch sizes and blue for metric sizes.



This universal stand will accommodate a wide variety of Eklind products (T-Keys and Ball-Hex-Drivers™) in inch and metric sizes. They can be attached to a wall, to a bench, or to each other.



## Eklind® BALL•HEX•DRIVER™ INCH SETS

		KEY SIZES												
ITEM NO.	NO. of KEYS	.050	1/16	5/64	3/32	7/64	1/8	9/64	5/32	3/16	7/32	1/4	5/16	3/8
<b>SETS IN STANDS</b>														
90114	13	[Red line across all key sizes]												
<b>SETS IN POUCHES</b>														
90113	13	[Red line across all key sizes]												
90108	8	[Red line across key sizes 1/16 to 1/4]												
90109	9	[Red line across key sizes 5/64 to 3/8]												



## Eklind® BALL•HEX•DRIVER™ METRIC SETS

		KEY SIZES									
ITEM NO.	NO. of KEYS	1.3	1.5	2.0	2.5	3.0	4.0	5.0	6.0	8.0	10.0
<b>SETS IN STANDS</b>											
90611	10	[Blue line across all key sizes]									
<b>SETS IN POUCHES</b>											
90609	9	[Blue line across key sizes 1.5 to 6.0]									
90607	7	[Blue line across key sizes 1.3 to 4.0]									



# INDIVIDUAL BALL-HEX-L™ KEYS



ITEM NO.	DIMENSIONS		
	TIP SIZE	LONG ARM (INCH)	SHORT ARM (INCH)
<b>BALL-HEX-L™ KEYS - INCH SIZES / LONG SERIES</b>			
18203	.050	2.84	0.53
18204	1/16	3.00	0.56
18205	5/64	3.19	0.61
18206	3/32	3.38	0.66
18207	7/64	3.56	0.70
18208	1/8	3.75	0.75
18209	9/64	3.94	0.80
18210	5/32	4.12	0.84
18212	3/16	4.50	0.94
18214	7/32	4.88	1.03
18216	1/4	5.25	1.12
18220	5/16	6.00	1.25
18224	3/8	6.75	1.38
18228	7/16	7.50	1.50
18232	1/2	8.25	1.63
18236	9/16	9.00	1.75
18240	5/8	9.75	1.88
18248	3/4	11.25	2.13
18256	7/8	13.88	3.03
18264	1	13.88	3.03
<b>BALL-HEX-L™ KEYS - INCH SIZES / STUBBY SERIES</b>			
18103	.050	2.84	0.16
18104	1/16	3.00	0.17
18105	5/64	3.19	0.29
18106	3/32	3.38	0.30
18107	7/64	3.56	0.32
18108	1/8	3.75	0.33
18109	9/64	3.94	0.35
18110	5/32	4.12	0.37
18112	3/16	4.50	0.41
18114	7/32	4.88	0.49
18116	1/4	5.25	0.48
18120	5/16	6.00	0.62
18124	3/8	6.75	0.75

ITEM NO.	DIMENSIONS		
	TIP SIZE	LONG ARM (INCH)	SHORT ARM (INCH)
<b>BALL-HEX-L™ KEYS - METRIC SIZES / LONG SERIES</b>			
18602	1.3	2.84	0.53
18603	1.5	3.03	0.53
18604	2.0	3.19	0.61
18605	2.5	3.48	0.69
18606	3.0	3.88	0.75
18607	3.5	4.00	0.84
18608	4.0	4.09	0.94
18609	4.5	4.34	1.00
18610	5.0	4.57	1.06
18611	5.5	5.01	1.13
18612	6.0	5.43	1.22
18614	7.0	6.20	1.38
18616	8.0	6.20	1.38
18618	9.0	6.58	1.54
18620	10.0	6.58	1.54
18622	11.0	6.88	1.50
18624	12.0	8.23	1.73
18628	14.0	9.15	2.15
18634	17.0	9.69	2.42
18638	19.0	10.85	2.70
18644	22.0	14.00	3.03
18648	24.0	14.25	3.03
<b>BALL-HEX-L™ KEYS - METRIC SIZES / STUBBY SERIES</b>			
18503	1.5	3.03	0.16
18504	2.0	3.19	0.29
18505	2.5	3.48	0.30
18506	3.0	3.88	0.34
18508	4.0	4.09	0.37
18510	5.0	4.57	0.42
18512	6.0	5.43	0.49
18516	8.0	6.20	0.62
18520	10.0	6.58	0.75

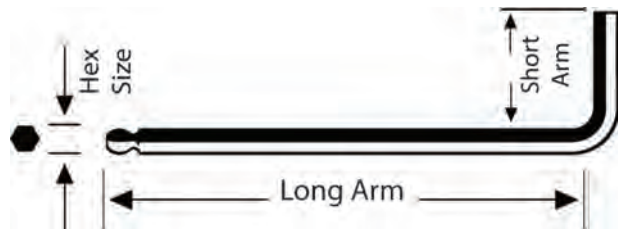

ITEM NO.	DIMENSIONS		
	TIP SIZE	LONG ARM (INCH)	SHORT ARM (INCH)
<b>DOUBLE BALL-HEX-L™ KEYS - INCH SIZES / X-LONG</b>			
19203	.050	3.10	0.25
19204	1/16	3.50	0.27
19205	5/64	3.90	0.29
19206	3/32	4.15	0.30
19207	7/64	4.41	0.31
19208	1/8	4.75	0.33
19209	9/64	5.11	0.34
19210	5/32	5.46	0.37
19212	3/16	6.15	0.41
19214	7/32	6.48	0.49
19216	1/4	6.81	0.48
19220	5/16	7.55	0.62
19224	3/8	8.50	0.77

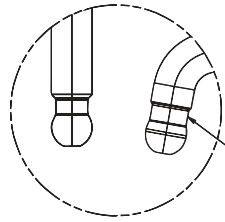

ITEM NO.	DIMENSIONS		
	TIP SIZE	LONG ARM (INCH)	SHORT ARM (INCH)
<b>DOUBLE BALL-HEX-L™ KEYS - METRIC SIZES / X-LONG</b>			
19603	1.5	3.5	0.27
19604	2.0	3.9	0.29
19605	2.5	4.33	0.30
19606	3.0	4.88	0.34
19608	4.0	5.43	0.37
19610	5.0	6.19	0.42
19612	6.0	7.01	0.49
19616	8.0	7.76	0.62
19620	10.0	8.71	0.81

ITEM NO.	DIMENSIONS		
	TIP SIZE	LONG ARM (INCH)	SHORT ARM (INCH)
<b>BRIGHT BALL-HEX-L™ KEYS - INCH SIZES / LONG</b>			
18303	.050	2.84	0.53
18304	1/16	3.00	0.56
18305	5/64	3.19	0.61
18306	3/32	3.38	0.66
18307	7/64	3.56	0.70
18308	1/8	3.75	0.75
18309	9/64	3.94	0.80
18310	5/32	4.12	0.84
18312	3/16	4.50	0.94
18314	7/32	4.88	1.03
18316	1/4	5.25	1.12
18320	5/16	6.00	1.25
18324	3/8	6.75	1.38
<b>BRIGHT BALL-HEX-L™ KEYS - INCH SIZES / X-LONG</b>			
19303	.050	3.10	0.53
19304	1/16	3.50	0.56
19305	5/64	3.90	0.61
19306	3/32	4.15	0.66
19307	7/64	4.41	0.70
19308	1/8	4.75	0.75
19309	9/64	5.11	0.80
19310	5/32	5.46	0.84
19312	3/16	6.15	0.94
19314	7/32	6.48	1.03
19316	1/4	6.82	1.12
19320	5/16	7.56	1.25
19324	3/8	8.50	1.38



ITEM NO.	DIMENSIONS		
	TIP SIZE	LONG ARM (INCH)	SHORT ARM (INCH)
<b>BRIGHT BALL-HEX-L™ KEYS - METRIC SIZES / LONG</b>			
18703	1.5	3.03	0.53
18704	2.0	3.19	0.61
18705	2.5	3.48	0.69
18706	3.0	3.88	0.75
18708	4.0	4.09	0.94
18710	5.0	4.57	1.06
18712	6.0	5.43	1.22
18716	8.0	6.20	1.38
18720	10.0	6.58	1.54
<b>BRIGHT BALL-HEX-L™ KEYS - METRIC SIZES / X-LONG</b>			
19703	1.5	3.50	0.53
19704	2.0	3.90	0.61
19705	2.5	4.33	0.69
19706	3.0	4.88	0.75
19708	4.0	5.43	0.94
19710	5.0	6.19	1.06
19712	6.0	7.00	1.22
19716	8.0	7.76	1.38
19720	10.0	8.70	1.54

**Double Ball Series has a thicker ball tip on the short arm for more torque, 100° angle for easier entry, 20° range of motion and you can safely access areas that are hard to reach.**



# INDIVIDUAL HEX-L® KEYS / INCH SIZES



ITEM NO.	DIMENSIONS		
	TIP SIZE	LONG ARM (INCH)	SHORT ARM (INCH)
<b>HEX-L® KEYS - INCH SIZES / SHORT SERIES</b>			
15101	.028	1.22	0.22
15102	.035	1.22	0.34
15103	.050	1.66	0.53
15104	1/16	1.75	0.56
15105	5/64	1.93	0.61
15106	3/32	2.00	0.66
15107	7/64	2.12	0.70
15108	1/8	2.25	0.75
15109	9/64	2.38	0.80
15110	5/32	2.50	0.84
15112	3/16	2.75	0.94
15114	7/32	3.00	1.03
15116	1/4	3.25	1.12
15120	5/16	3.75	1.25
15124	3/8	4.25	1.38
15128	7/16	4.75	1.50
15132	1/2	5.25	1.63
15136	9/16	5.75	1.75
15140	5/8	6.25	1.88
15148	3/4	7.25	2.13
15156	7/8	8.25	2.38
15164	1	9.25	2.63
15166	1 1/8	10.25	2.75
15168	1 1/4	12.11	4.80
15172	1 1/2	13.25	3.50
15176	1 3/4	15.25	4.00
15180	2	17.25	4.50
<b>HEX-L® KEYS - INCH SIZES / 6" SERIES</b>			
15305	5/64	6.00	0.61
15306	3/32	6.00	0.66
15307	7/64	6.00	0.70
15308	1/8	6.00	0.75
15309	9/64	6.00	0.80
15310	5/32	6.00	0.84
15312	3/16	6.00	0.94
15314	7/32	6.00	1.03
15316	1/4	6.00	1.12
15320	5/16	6.00	1.25
15324	3/8	6.00	1.38



ITEM NO.	DIMENSIONS		
	TIP SIZE	LONG ARM (INCH)	SHORT ARM (INCH)
<b>HEX-L® KEYS - INCH SIZES / LONG SERIES</b>			
15201	.028	2.60	0.21
15202	.035	2.67	0.34
15203	.050	2.84	0.53
15204	1/16	3.00	0.56
15205	5/64	3.19	0.61
15206	3/32	3.38	0.66
15207	7/64	3.56	0.70
15208	1/8	3.75	0.75
15209	9/64	3.94	0.80
15210	5/32	4.12	0.84
15212	3/16	4.50	0.94
15214	7/32	4.88	1.03
15216	1/4	5.25	1.12
15220	5/16	6.00	1.25
15224	3/8	6.75	1.38
15228	7/16	7.50	1.50
15232	1/2	8.25	1.63
15236	9/16	9.00	1.75
15240	5/8	9.75	1.88
15248	3/4	11.25	2.13
15256	7/8	12.75	2.38
15264	1	14.25	2.63
15266	1 1/8	15.75	2.75
15268	1 1/4	19.80	4.80
15272	1 1/2	20.25	5.44
15276	1 3/4	23.25	4.50
15280	2	26.38	4.50
<b>HEX-L® KEYS - INCH SIZES / 12" SERIES</b>			
15405	5/64	12.00	0.61
15406	3/32	12.00	0.66
15408	1/8	12.00	0.75
15410	5/32	12.00	0.84
15412	3/16	12.00	0.94
15414	7/32	12.00	1.03
15416	1/4	12.00	1.12
<b>TAMPER RESISTANT HEX-L® KEYS / INCH SIZES</b>			
90206	3/32	5.25	1.00
90208	1/8	5.25	1.00
90210	5/32	5.25	1.20
90212	3/16	5.25	1.20
90214	7/32	5.25	1.20
90216	1/4	5.25	1.38
90220	5/16	5.25	1.38
90224	3/8	5.25	1.38

ITEM NO.	DIMENSIONS		
	TIP SIZE	LONG ARM (INCH)	SHORT ARM (INCH)
<b>HEX-L® KEYS - METRIC SIZES / SHORT SERIES</b>			
15500	0.7	1.22	0.22
15501	0.9	1.22	0.34
15502	1.3	1.63	0.53
15503	1.5	1.73	0.53
15504	2.0	1.93	0.61
15505	2.5	2.15	0.69
15506	3.0	2.42	0.75
15507	3.5	2.54	0.84
15508	4.0	2.68	0.94
15509	4.5	2.86	1.00
15510	5.0	3.08	1.06
15511	5.5	3.26	1.13
15512	6.0	3.46	1.22
15514	7.0	3.65	1.38
15516	8.0	3.84	1.38
15518	9.0	4.07	1.54
15520	10.0	4.29	1.54
15522	11.0	4.75	1.50
15524	12.0	4.80	1.73
15528	14.0	5.37	2.15
15534	17.0	6.14	2.42
15538	19.0	6.91	2.70
15544	22.0	7.68	3.07
15548	24.0	8.60	3.46
15551	27.0	9.61	3.84
15556	32.0	12.11	4.80
15560	36.0	13.64	5.37

ITEM NO.	DIMENSIONS		
	TIP SIZE	LONG ARM (INCH)	SHORT ARM (INCH)
<b>HEX-L® KEYS - METRIC SIZES / LONG SERIES</b>			
15600	0.7	2.60	0.21
15601	0.9	2.67	0.34
15602	1.3	2.84	0.53
15603	1.5	3.03	0.53
15604	2.0	3.19	0.61
15605	2.5	3.48	0.69
15606	3.0	3.88	0.75
15607	3.5	3.98	0.84
15608	4.0	4.09	0.94
15609	4.5	4.32	1.00
15610	5.0	4.57	1.06
15611	5.5	4.99	1.13
15612	6.0	5.43	1.22
15614	7.0	6.20	1.38
15616	8.0	6.20	1.38
15618	9.0	6.58	1.54
15620	10.0	6.58	1.54
15622	11.0	7.50	1.50
15624	12.0	8.23	1.73
15628	14.0	9.15	2.15
15634	17.0	9.69	2.42
15638	19.0	10.85	2.70
15644	22.0	13.00	3.07
15648	24.0	14.25	3.46
15651	27.0	16.26	3.84
15656	32.0	19.80	4.80
15660	36.0	20.25	5.37

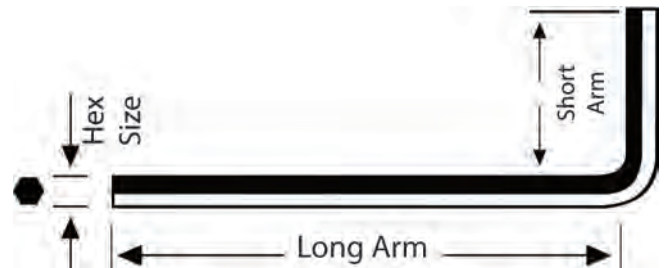



# INDIVIDUAL BRIGHT SERIES HEX-L® KEYS



ITEM NO.	DIMENSIONS		
	TIP SIZE	LONG ARM (INCH)	SHORT ARM (INCH)
<b>BRIGHT HEX-L® KEYS - INCH SIZES / SHORT SERIES</b>			
16103	.050	1.66	0.53
16104	1/16	1.75	0.56
16105	5/64	1.93	0.61
16106	3/32	2.00	0.66
16107	7/64	2.12	0.70
16108	1/8	2.25	0.75
16109	9/64	2.38	0.80
16110	5/32	2.50	0.84
16112	3/16	2.75	0.94
16114	7/32	3.00	1.03
16116	1/4	3.25	1.12
16120	5/16	3.75	1.25
16124	3/8	4.25	1.38
16128	7/16	4.75	1.50
16132	1/2	5.25	1.63
<b>BRIGHT HEX-L® KEYS - INCH SIZES / LONG SERIES</b>			
16203	.050	2.84	0.53
16204	1/16	3.00	0.56
16205	5/64	3.19	0.61
16206	3/32	3.38	0.66
16207	7/64	3.56	0.70
16208	1/8	3.75	0.75
16209	9/64	3.94	0.80
16210	5/32	4.12	0.84
16212	3/16	4.50	0.94
16214	7/32	4.88	1.03
16216	1/4	5.25	1.12
16220	5/16	6.00	1.25
16224	3/8	6.75	1.38
16228	7/16	7.50	1.50
16232	1/2	8.25	1.63

ITEM NO.	DIMENSIONS		
	TIP SIZE	LONG ARM (INCH)	SHORT ARM (INCH)
<b>BRIGHT HEX-L® KEYS - METRIC SIZES / SHORT SERIES</b>			
16503	1.5	1.73	0.53
16504	2.0	1.93	0.61
16505	2.5	2.15	0.69
16506	3.0	2.42	0.75
16508	4.0	2.68	0.94
16510	5.0	3.08	1.06
16512	6.0	3.46	1.22
16514	7.0	3.65	1.38
16516	8.0	3.84	1.38
16518	9.0	4.07	1.41
16520	10.0	4.29	1.54
16522	11.0	4.75	1.50
16524	12.0	4.80	1.73
<b>BRIGHT HEX-L® KEYS - METRIC SIZES / LONG SERIES</b>			
16603	1.5	3.03	0.53
16604	2.0	3.19	0.61
16605	2.5	3.48	0.69
16606	3.0	3.88	0.75
16608	4.0	4.09	0.94
16610	5.0	4.57	1.06
16612	6.0	5.43	1.22
16614	7.0	5.75	1.18
16616	8.0	6.20	1.38
16618	9.0	6.18	1.41
16620	10.0	6.58	1.54
16622	11.0	7.50	1.50
16624	12.0	8.23	1.73

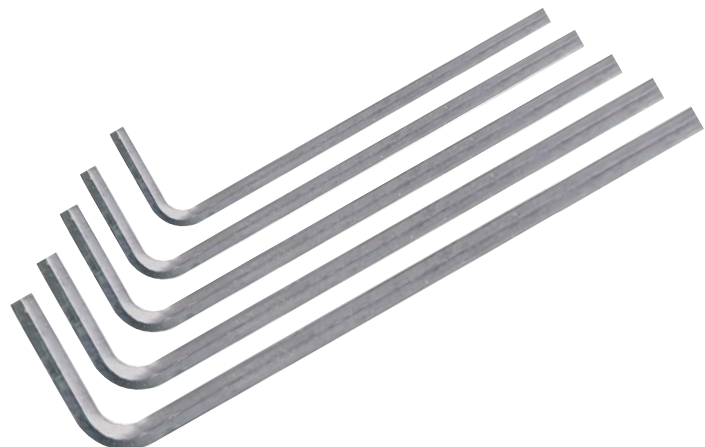

**“Bright” Hex-L® Keys from Eklind!**  
 Bright series keys are manufactured from the same high quality standards that are consistent with Eklind’s entire line of Hex Key Products.

ITEM NO.	DIMENSIONS		
	TIP SIZE	LONG ARM (INCH)	SHORT ARM (INCH)
<b>TORX® L-KEYS / SHORT SERIES</b>			
15805	T5	1.54	0.61
15806	T6	1.59	0.61
15807	T7	1.72	0.61
15808	T8	1.82	0.61
15809	T9	1.92	0.61
15810	T10	2.00	0.66
15815	T15	2.13	0.71
15820	T20	2.25	0.75
15825	T25	2.38	0.80
15827	T27	2.50	0.85
15830	T30	2.75	0.94
15840	T40	3.00	1.03
15845	T45	3.25	1.13
15850	T50	3.75	1.25
15855	T55	4.25	1.38
15860	T60	4.75	1.50
<b>BRIGHT TORX® L-KEYS / SHORT SERIES</b>			
16810	T10	2.00	0.66
16815	T15	2.13	0.71
16820	T20	2.25	0.75
16825	T25	2.38	0.80
16827	T27	2.50	0.85
16830	T30	2.75	0.94
16840	T40	3.00	1.03
16845	T45	3.25	1.13
16850	T50	3.75	1.25
16855	T55	4.25	1.38
<b>TAMPER RESISTANT TORX® L-KEYS / LONG SERIES</b>			
15706	T6	2.95	0.61
15707	T7	3.05	0.61
15708	T8	3.15	0.61
15709	T9	3.25	0.61
15710	T10	3.38	0.66
15715	T15	3.57	0.71
15720	T20	3.79	0.75
15725	T25	3.94	0.80
15727	T27	4.17	0.85
15730	T30	4.50	0.94
15740	T40	4.88	1.03
15745	T45	5.25	1.13
15750	T50	6.00	1.25
15755	T55	6.75	1.38
15760	T60	7.50	1.50

ITEM NO.	DIMENSIONS		
	TIP SIZE	LONG ARM (INCH)	SHORT ARM (INCH)
<b>TORX® L-KEYS / LONG SERIES</b>			
15905	T5	2.85	0.53
15906	T6	2.95	0.61
15907	T7	3.05	0.61
15908	T8	3.15	0.61
15909	T9	3.25	0.61
15910	T10	3.38	0.66
15915	T15	3.57	0.71
15920	T20	3.79	0.75
15925	T25	3.94	0.80
15927	T27	4.17	0.85
15930	T30	4.50	0.94
15940	T40	4.88	1.03
15945	T45	5.25	1.13
15950	T50	6.00	1.25
15955	T55	6.75	1.38
15960	T60	7.50	1.50
<b>BRIGHT TORX® L-KEYS / LONG SERIES</b>			
16910	T10	3.38	0.66
16915	T15	3.57	0.71
16920	T20	3.79	0.75
16925	T25	3.94	0.80
16927	T27	4.17	0.85
16930	T30	4.50	0.94
16940	T40	4.88	1.03
16945	T45	5.25	1.13
16950	T50	6.00	1.25
16955	T55	6.75	1.38
<b>BALL TORX® L-KEYS / LONG SERIES</b>			
15006	T6	2.95	0.61
15007	T7	3.05	0.61
15008	T8	3.15	0.61
15009	T9	3.25	0.61
15010	T10	3.38	0.66
15015	T15	3.57	0.71
15020	T20	3.79	0.75
15025	T25	3.94	0.80
15027	T27	4.17	0.85
15030	T30	4.50	0.94
15040	T40	4.88	1.03
15045	T45	5.25	1.13
15050	T50	6.00	1.25
15055	T55	6.75	1.38
15060	T60	7.50	1.50





# INDIVIDUAL POWER-T™ KEYS



ITEM NO.	DIMENSIONS		
	TIP SIZE	HANDLE WIDTH (INCH)	SHAFT LENGTH (INCH)
<b>POWER-T™ HEX KEYS - INCH SIZES / 6" SERIES</b>			
61605	5/64	3	6
61606	3/32	3	6
61607	7/64	3	6
61608	1/8	3	6
61609	9/64	3	6
61610	5/32	3	6
61612	3/16	4	6
61614	7/32	4	6
61616	1/4	4	6
61620	5/16	5	6
61624	3/8	5	6
<b>POWER-T™ HEX KEYS - INCH SIZES / 9" SERIES</b>			
61905	5/64	3	9
61906	3/32	3	9
61907	7/64	3	9
61908	1/8	3	9
61909	9/64	3	9
61910	5/32	3	9
61912	3/16	4	9
61914	7/32	4	9
61916	1/4	4	9
61920	5/16	5	9
61924	3/8	5	9
<b>POWER-T™ HEX KEYS - METRIC SIZES / 6" SERIES</b>			
64620	2.0	3	6
64625	2.5	3	6
64630	3.0	3	6
64640	4.0	3	6
64650	5.0	4	6
64660	6.0	4	6
64670	7.0	5	6
64680	8.0	5	6
64685	9.0	5	6
64690	10.0	5	6
<b>POWER-T™ HEX KEYS - METRIC SIZES / 9" SERIES</b>			
64920	2.0	3	9
64925	2.5	3	9
64930	3.0	3	9
64940	4.0	3	9
64950	5.0	4	9
64960	6.0	4	9
64970	7.0	5	9
64980	8.0	5	9
64985	9.0	5	9
64990	10.0	5	9

ITEM NO.	DIMENSIONS		
	TIP SIZE	HANDLE WIDTH (INCH)	SHAFT LENGTH (INCH)
<b>POWER-T™ TORX KEYS / 6" SERIES</b>			
68606	T6	3	6
68607	T8	3	6
68608	T8	3	6
68609	T9	3	6
68610	T10	3	6
68615	T15	3	6
68620	T20	3	6
68625	T25	3	6
68627	T27	4	6
68640	T30	4	6
68640	T40	4	6
68645	T45	5	6
68650	T50	5	6
<b>POWER-T™ TORX KEYS / 9" SERIES</b>			
68906	T6	3	9
68907	T7	3	9
68908	T8	3	9
68909	T9	3	9
68910	T10	3	9
68915	T15	3	9
68920	T20	3	9
68925	T25	3	9
68927	T27	4	9
68930	T30	4	9
68940	T40	4	9
68945	T45	5	9
68950	T50	5	9
<b>POWER-T™ BALL-HEX KEYS - INCH SIZES / 9" SERIES</b>			
61805	5/64	3	9
61806	3/32	3	9
61807	7/64	3	9
61808	1/8	3	9
61809	9/64	3	9
61810	5/32	3	9
61812	3/16	4	9
61814	7/32	4	9
61816	1/4	4	9
61820	5/16	5	9
61824	3/8	5	9
<b>POWER-T™ BALL-HEX KEYS - METRIC SIZES / 9" SERIES</b>			
64820	2.0	3	9
64825	2.5	3	9
64830	3.0	3	9
64840	4.0	3	9
64850	5.0	4	9
64860	6.0	4	9
64870	7.0	5	9
67880	8.0	5	9
64885	9.0	5	9
64890	10.0	5	9

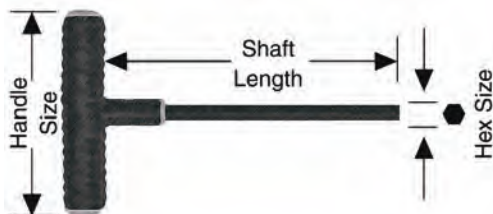

ITEM NO.	DIMENSIONS		
	TIP SIZE	HANDLE WIDTH (INCH)	SHAFT LENGTH (INCH)
<b>CUSHION GRIP HEX T-KEYS - INCH SIZES / 6" SERIES</b>			
51605	5/64	3	6
51606	3/32	3	6
51607	7/64	3	6
51608	1/8	3	6
51609	9/64	3	6
51610	5/32	3	6
51612	3/16	4	6
51614	7/32	4	6
51616	1/4	4	6
51620	5/16	6	6
51624	3/8	6	6
51628	7/16	6	6
51632	1/2	6	6
<b>CUSHION GRIP HEX T-KEYS - INCH SIZES / 9" SERIES</b>			
51905	5/64	3	9
51906	3/32	3	9
51907	7/64	3	9
51908	1/8	3	9
51909	9/64	3	9
51910	5/32	3	9
51912	3/16	4	9
51914	7/32	4	9
51916	1/4	4	9
51920	5/16	6	9
51924	3/8	6	9
51928	7/16	6	9
51932	1/2	6	9
<b>CUSHION GRIP HEX T-KEYS - METRIC SIZES / 6" SERIES</b>			
54620	2.0	3	6
54625	2.5	3	6
54630	3.0	3	6
54640	4.0	3	6
54650	5.0	4	6
54660	6.0	4	6
54680	8.0	6	6
54690	10.0	6	6
54691	11.0	6	6
54692	12.0	6	6
<b>CUSHION GRIP HEX T-KEYS - METRIC SIZES / 9" SERIES</b>			
54920	2.0	3	9
54925	2.5	3	9
54930	3.0	3	9
54940	4.0	3	9
54950	5.0	4	9
54960	6.0	4	9
54980	8.0	6	9
54990	10.0	6	9
54991	11.0	6	9
54992	12.0	6	9

ITEM NO.	DIMENSIONS		
	TIP SIZE	HANDLE WIDTH (INCH)	SHAFT LENGTH (INCH)
<b>CUSHION GRIP HEX T-KEYS - INCH SIZES / 12" SERIES</b>			
51205	5/64	3	12
51206	3/32	3	12
51207	7/64	3	12
51208	1/8	3	12
51209	9/64	3	12
51210	5/32	3	12
51212	3/16	4	12
51214	7/32	4	12
51216	1/4	4	12
51220	5/16	6	12
51224	3/8	6	12
51232	1/2	6	12
<b>CUSHION GRIP HEX T-KEYS - INCH SIZES / 15" SERIES</b>			
51505	5/64	3	15
51506	3/32	3	15
51507	7/64	3	15
51508	1/8	3	15
51509	9/64	3	15
51510	5/32	3	15
51512	3/16	4	15
51514	7/32	4	15
51516	1/4	4	15
51520	5/16	6	15
51524	3/8	6	15
51532	1/2	6	15
<b>CUSHION GRIP HEX T-KEYS - METRIC SIZES / 12" SERIES</b>			
54220	2.0	3	12
54225	2.5	3	12
54230	3.0	3	12
54240	4.0	3	12
54250	5.0	4	12
54260	6.0	4	12
54280	8.0	6	12
54290	10.0	6	12
54292	12.0	6	12
<b>CUSHION GRIP HEX T-KEYS - METRIC SIZES / 15" SERIES</b>			
54520	2.0	3	15
54525	2.5	3	15
54530	3.0	3	15
54540	4.0	3	15
54550	5.0	4	15
54560	6.0	4	15
54580	8.0	6	15
54590	10.0	6	15
54592	12.0	6	15

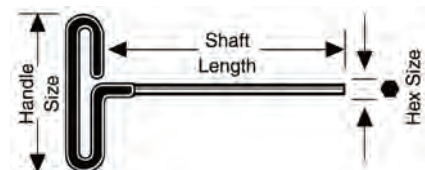



# INDIVIDUAL STANDARD GRIP HEX T-KEYS



ITEM NO.	DIMENSIONS		
	TIP SIZE	HANDLE WIDTH (INCH)	SHAFT LENGTH (INCH)
<b>STANDARD GRIP HEX T-KEYS - INCH SIZES / 3" SERIES</b>			
31305	5/64	3	3
31306	3/32	3	3
31307	7/64	3	3
31308	1/8	3	3
31309	9/64	3	3
31310	5/32	3	3
31312	3/16	4	3
31314	7/32	4	3
31316	1/4	4	3
31320	5/16	6	3
31324	3/8	6	3
<b>STANDARD GRIP HEX T-KEYS - INCH SIZES / 6" SERIES</b>			
31605	5/64	3	6
31606	3/32	3	6
31607	7/64	3	6
31608	1/8	3	6
31609	9/64	3	6
31610	5/32	3	6
31612	3/16	4	6
31614	7/32	4	6
31616	1/4	4	6
31620	5/16	6	6
31624	3/8	6	6
<b>STANDARD GRIP HEX T-KEYS - INCH SIZES / 9" SERIES</b>			
31905	5/64	3	9
31906	3/32	3	9
31907	7/64	3	9
31908	1/8	3	9
31909	9/64	3	9
31910	5/32	3	9
31912	3/16	4	9
31914	7/32	4	9
31916	1/4	4	9
31920	5/16	6	9
31924	3/8	6	9



ITEM NO.	DIMENSIONS		
	TIP SIZE	HANDLE WIDTH (INCH)	SHAFT LENGTH (INCH)
<b>STANDARD GRIP HEX T-KEYS - METRIC SIZES / 6" SERIES</b>			
34620	2.0	3	6
34625	2.5	3	6
34630	3.0	3	6
34640	4.0	3	6
34650	5.0	4	6
34660	6.0	4	6
34680	8.0	6	6
34690	10.0	6	6
<b>STANDARD GRIP HEX T-KEYS - METRIC SIZES / 9" SERIES</b>			
34920	2.0	3	9
34925	2.5	3	9
34930	3.0	3	9
34940	4.0	3	9
34950	5.0	4	9
34960	6.0	4	9
34980	8.0	6	9
34990	10.0	6	9

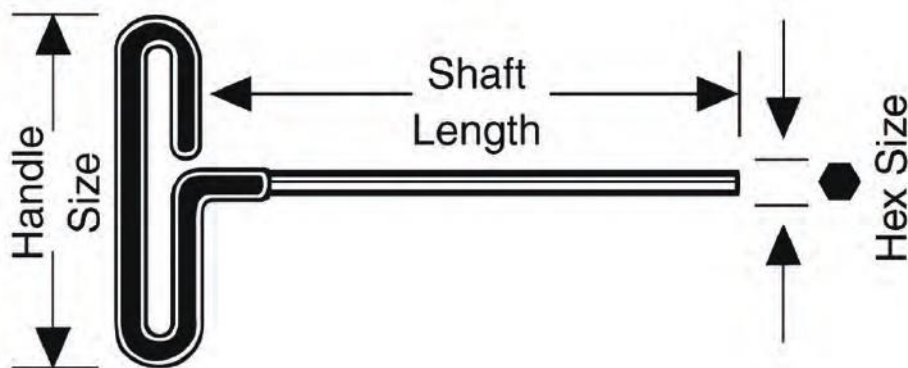

ITEM NO.	DESCRIPTION		
	TIP STYLE	COLOR	TIP SIZE
92301	Hex	Red	.028"
92302	Hex	Red	.035"
92303	Hex	Red	.050"
92304	Hex	Red	1/16"
92305	Hex	Red	5/64"
92306	Hex	Red	3/32"
92307	Hex	Red	7/64"
92308	Hex	Red	1/8"
92309	Hex	Red	9/64"
92310	Hex	Red	5/32"
92407	Hex	Blue	0.7MM
92409	Hex	Blue	0.9MM
92413	Hex	Blue	1.3MM
92415	Hex	Blue	1.5MM
92420	Hex	Blue	2.0MM
92425	Hex	Blue	2.5MM
92430	Hex	Blue	3.0MM
92440	Hex	Blue	4.0MM
92502	Ball Hex	Red	.035"
92503	Ball Hex	Red	.050"
92504	Ball Hex	Red	1/16"
92505	Ball Hex	Red	5/64"
92506	Ball Hex	Red	3/32"
92507	Ball Hex	Red	7/64"
92508	Ball Hex	Red	1/8"
92509	Ball Hex	Red	9/64"
92510	Ball Hex	Red	5/32"
92609	Ball Hex	Blue	0.9MM
92613	Ball Hex	Blue	1.3MM
92615	Ball Hex	Blue	1.5MM
92620	Ball Hex	Blue	2.0MM
92625	Ball Hex	Blue	2.5MM
92630	Ball Hex	Blue	3.0MM
92640	Ball Hex	Blue	4.0MM

ITEM NO.	DESCRIPTION		
	TIP STYLE	COLOR	TIP SIZE
92008	Slotted	Yellow	0.8MM
92010	Slotted	Yellow	1.0MM
92012	Slotted	Yellow	1.2MM
92015	Slotted	Yellow	1.5MM
92018	Slotted	Yellow	1.8MM
92020	Slotted	Yellow	2.0MM
92025	Slotted	Yellow	2.5MM
92030	Slotted	Yellow	3.0MM
92035	Slotted	Yellow	3.5MM
92040	Slotted	Yellow	4.0MM
92100	PoziDriv	Yellow	#0
92101	PoziDriv	Yellow	#1
92108	Phillips	Yellow	#000
92109	Phillips	Yellow	#00
92110	Phillips	Yellow	#0
92111	Phillips	Yellow	#1
92203	TORX®	Green	T3
92204	TORX®	Green	T4
92205	TORX®	Green	T5
92206	TORX®	Green	T6
92207	TORX®	Green	T7
92208	TORX®	Green	T8
92209	TORX®	Green	T9
92210	TORX®	Green	T10
92215	TORX®	Green	T15
92220	TORX®	Green	T20

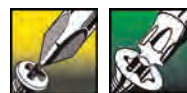



# INDIVIDUAL BALL-HEX DRIVERS™



ITEM NO.	DIMENSIONS		
	TIP SIZE	HANDLE SIZE	SHAFT LENGTH (INCH)
<b>BALL-HEX SCREWDRIVERS / INCH SIZES</b>			
91103	.050	P	2.7
91104	1/16	P	2.7
91105	5/64	P	2.7
91106	3/32	P	2.7
91107	7/64	P	2.7
91108	1/8	S	5
91109	9/64	S	5
91110	5/32	M	5.2
91112	3/16	M	5.2
91114	7/32	M	5.2
91116	1/4	L	5.5
91120	5/16	L	5.5
91124	3/8	L	5.5
91128	7/16	L	7.5
91132	1/2	L	8
<b>BALL-HEX SCREWDRIVERS / METRIC SIZES</b>			
91602	1.3	P	2.7
91603	1.5	P	2.7
91604	2.0	P	2.7
91605	2.5	S	2.7
91606	3.0	S	5.0
91608	4.0	M	5.2
91610	5.0	M	5.2
91612	6.0	L	5.5
91616	8.0	L	5.5
91620	10.0	L	5.5
91624	12.0	L	8.0



ITEM NO.	DIMENSIONS		
	WIDTH	HEIGHT	DEPTH
<b>UNIVERSAL HEX-KEY STAND</b>			
11111	7.50	6.00	5.50



Our Universal Hex-Key Stand stand will accommodate a wide variety of Eklind products; Inch, Metric and Torx®. They can be attached to a wall, to a bench or to each other.

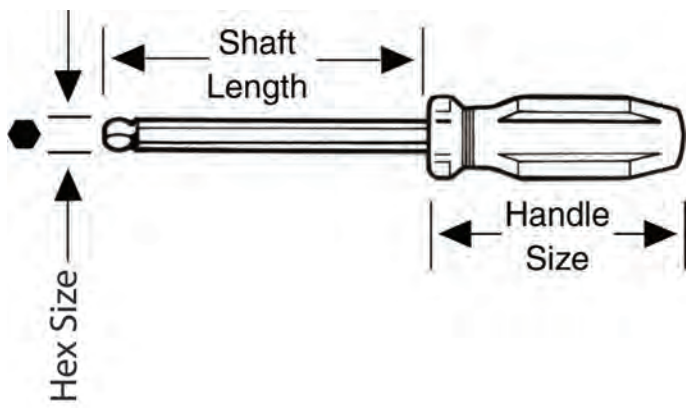

ITEM NO	MODELS																									
	HEX SIZE	LENGTH	20511	20811	20812	20911	20912	20519	20719	20919	25611	25911	25912	25519	25919	21151	21171	21172	21158	21159	25161	25171	25172	25159	25169	
<b>REPLACEMENT KEYS / FOLD UP INCH SETS</b>																										
24031	.050	1.8		•																						
24041	1/16	1.9		•									•													
24051	5/64	2.0		•									•													
24061	3/32	2.1		•			•						•													
28406	3/32	3.7			•																					
24071	7/64	2.3		•			•						•													
28407	7/64	3.8			•								•													
24081	1/8	2.4		•			•						•													
28408	1/8	3.9			•																					
24091	9/64	2.6		•			•						•													
28409	9/64	4.1			•																					
24101	5/32	2.7		•			•						•													
28410	5/32	4.2			•																					
24121	3/16	2.9																								
24122	3/16	3.3	•				•						•													
28412	3/16	4.7			•																					
24142	7/32	3.5	•				•						•													
28414	7/32	4.8			•																					
24162	1/4	3.7	•				•						•													
28416	1/4	5.0			•																					
25202	5/16	4.8	•																							
25242	3/8	5.1	•																							
<b>REPLACEMENT KEYS - FOLD-UP INCH SETS / BALL SERIES</b>																										
26041	1/16	1.9																								
26051	5/64	2.0																								
26061	3/32	2.1																								
26071	7/64	2.3																								
26081	1/8	2.4																								
26091	9/64	2.6																								
26101	5/32	2.7																								
26122	3/16	3.3																								
26142	7/32	3.5																								
26162	1/4	3.7																								
26202	5/16	4.8																								
26242	3/8	5.1																								
<b>REPLACEMENT KEYS / FOLD-UP METRIC SETS</b>																										
29015	1.5	1.8																								
29020	2.0	2.0																								
29025	2.5	2.2																								
29030	3.0	2.4																								
29103	3.0	3.3																								
29040	4.0	2.6																								
29104	4.0	3.5																								
29050	5.0	3.1																								
29105	5.0	3.8																								
29060	6.0	3.3																								
29116	6.0	3.8																								
29106	6.0	4.0																								
29080	8.0	4.1																								
29108	8.0	4.8																								
29110	10.0	5.1																								
<b>REPLACEMENT KEYS - FOLD-UP METRIC SETS / BALL SERIES</b>																										
27015	1.5	1.8																								
27020	2.0	2.0																								
27025	2.5	2.2																								
27030	3.0	2.4																								
27040	4.0	2.6																								
27104	4.0	3.5																								
27105	5.0	3.8																								
27106	6.0	4.0																								
27108	8.0	4.8																								
27110	10.0	5.1																								

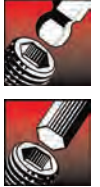



# REPLACEMENT KEYS / FOLD-UP SETS



ITEM NO.	MODELS											
	HEX SIZE	LENGTH	22451	22461	22571	22572	22651	25461	25570	25581	25582	25651
<b>REPLACEMENT KEYS - FOLD-UP TORX® SETS</b>												
23061	T6	1.7				★					★	
23071	T7	1.8				★					★	
23081	T8	2.0				★			★		★	
23092	T9	2.1				★					★	
23010	T10	2.7							★			
23101	T10	2.7			★					★		
23102	T10	2.4				★					★	
23015	T15	3.0							★			
23151	T15	3.0		★	★			★		★		
23152	T15	2.5				★					★	
23020	T20	3.2							★			
23201	T20	3.2			★					★		
23202	T20	2.8				★						
23025	T25	3.4							★			
23251	T25	3.4			★					★		
23027	T27	3.5							★			
23271	T27	3.5			★					★		
23030	T30	3.7							★			
23301	T30	3.7			★					★		
23040	T40	4.0							★			
23401	T40	3.9			★					★		
<b>REPLACEMENT KEYS - FOLD-UP INCH SCREWDRIVER SETS</b>												
27120	1/8 FB	2.4	✘	✘				✘	✘			
27180	3/16 FB	2.7	✘	✘			✘	✘				✘
27252	1/4 FB	3.2	✘	✘				✘	✘			
27181	#1 PB	3.1	✘	✘			✘	✘				✘
27182	AWL	2.6	✘	✘				✘				
29040	4MM	2.6					●					●
29050	5MM	3.1					●					●
29060	6MM	3.3					●					●



# REPLACEMENT PARTS / MOLDED HOLDERS

ITEM NO.	SERIES	NO. OF HOLES	MODELS																					
			10007	10018	10107	10111	10113	10207	10211	10213	10507	10509	10607	10609	10707	10807	10907	13207	13211	13212	13213	13607	13609	
<b>REPLACEMENT HOLDERS - HEX-L® KEY SETS</b>																								
19018	Inch	18		●																				
19107	Inch	7			●																			
19111	Inch	11				●																		
19113	Inch	13					●																	
19507	Metric	7																						
19509	Metric	9																						
19807	Torx®	7	●																					



# REPLACEMENT L-KEY METAL BOXES

ITEM NO.	DESCRIPTION
<b>REPLACEMENT METAL BOXES FOR L-KEYS</b>	
19518	Holds Up To 18 Short Series L-Keys (Inch, Metric or Torx®)
19618	Holds Up To 18 Long Series L-Keys (Inch, Metric or Torx®)





**Eklind**

# SCREW CHART

## INCH SIZES

Hex Size	CAP SCREWS					Set Screws	Shoulder Screws	Pressure Plug
	Socket Head 1936	Socket Head 1960	Flat Head	Button Head	Low Head			
.028						0		
.035			0	0		1, 2		
.050	0, 1	0	1, 2	1, 2	4	3, 4		
1/16	2	1	3, 4	3, 4	5, 6	5, 6		
5/64	3, 4	2, 3	5, 6	5, 6	8	8		
3/32	5, 6	4, 5	8	8	10	10		
7/64		6						
1/8	8		10	10	1/4	1/4	1/4	
9/64	10	8						
5/32	1/4	10	1/4	1/4	5/16	5/16	5/16	1/16
3/16	1/4	1/4	5/16	5/16	3/8	3/8	3/8	1/8
7/32	5/16		3/8	3/8	7/16	7/16		
1/4		5/16	7/16		1/2	1/2	1/2	1/4
5/16	3/8, 7/16	3/8	1/2	1/2	5/8	5/8	5/8	3/8
3/8	1/2	7/16, 1/2	5/8	5/8		3/4	3/4	1/2
7/16		9/16						
1/2	5/8	5/8	3/4			7/8	1	
9/16	3/4, 7/8		7/8			1, 1-1/8		3/4
5/8	1	3/4	1			1-1/4, 1-3/8	1-1/4	1
3/4	1-1/8, 1-1/4, 1-3/8	7/8, 1	1-1/8			1-1/2		1-1/4
7/8		1-1/8, 1-1/4	1-1/4, 1-3/8				1-1/2	
1	1-1/2	1-3/8, 1-1/2	1-1/2			1-3/4, 2	1-3/4	1-1/2, 2
1-1/4		1-3/4					2	
1-1/2		2						
1-3/4		2-1/4, 2-1/2						
2		2-3/4						

## METRIC SIZES

Hex Size	CAP SCREWS				Set Screws	Shoulder Screws
	Socket Head	Flat Head	Button Head	Low Head		
.07					1.4, 1.6, 1.8	
.09					2, 2.3	
1.3	1.4				2.5, 2.6	
1.5	1.6, 2				3	
2	2.5	3	3		4	
2.5	3	4	4		5	
3	4	5	5	4	6	5
4	5	6	6	5	8	6
5	6	8	8	6	10	8
6	8	10	10	8	12, 14	10
8	10	12	12	10	16	12
10	12	14, 16	14, 16	12	18, 20	16
12	14	18, 20	18, 20	14	22, 24	20
14	16, 18	22, 24	22, 24	16		
17	20, 22			20, 22		
19	24, 27			24		

## TORX® SIZES

Torx® Size	CAP SCREWS			Set Screws
	Socket Head	Flat Head	Button Head	
T6				M3
T7			#4	#6
T8				#8, M4
T9		#4		
T10	#4, #5, M3	#5, M3	#6, M3	#10, M5
T15	#6	#6	#8	
T20		#8, M4	M4	1/4, M6
T25	#8, M4	#10, M5	#10, M5	
T27	#10, M5		1/4	5/16, M8
T30	1/4, M6	1/4, M6	M6	3/8
T40		5/16, M8	5/16, M8	M10
T45	5/16, M8	3/8	3/8	1/2, M12
T50	3/8, M10	M10	M10	M14
T55	M12	5/8, M12	1/2, M12	M16
T60	M14	3/4, M16	5/8, M16	M20

*Eklind Industrial Quality Standards are strictly controlled to meet or exceed all applicable ASME and ANSI standards. All Eklind products are warranted against defects in materials and workmanship. Any tool that is abused or misused is excluded from this warranty. Upon return of the product, our quality assurance department will assess the claim and the product will be replaced if it is covered by this warranty.*

WWW.EKLINDTOOL.COM

## Eklind Tool Company

11040 King Street • Franklin Park, IL 60131-1432

Phone: 847.994.8550 • Fax: 847.994.8526

Email: sales@ekindtool.net • www.ekindtool.com